

FUZHOU RAJEYN ELECTRONIC SCI-TEC., LTD.

ADD: No 1 Shiziting Road, Cangshan district, Fuzhou city, Fujian Province P.C.: 350008
 Email: info@rajeyn.com Tel: +86-591-83519869

General Information	
Model	RJY-30-S203AD
Type	Concealed Toilet Sensor Flusher
Material	304 Stainless Steel Sensor Panel
Valve	Pulse solenoid valve
Net Weight	1.8kg
Gross Weight	2.5kg
Warranty	One Year
Technical Parameters	
Working Voltage	DC3V & AC220V
Average static power	<40uA
Instant dynamic power	<600mA
Working water pressure	0.2-0.7MPa
Default Sensor distance	65±6cm to Standard White Board (About 45cm to Human Body)
Adjustable Sensor Range	50-80cm to Standard White Board
Response Time	3S
Flush duration	After-flush: 4s
Environment temperature	1~40°C
Medium temperature	0~65°C
Inlet/Outlet diameter	G1"
Package Information	
Inner package	375*165*112
Outer package	525*395*360
Quantity per carton	9

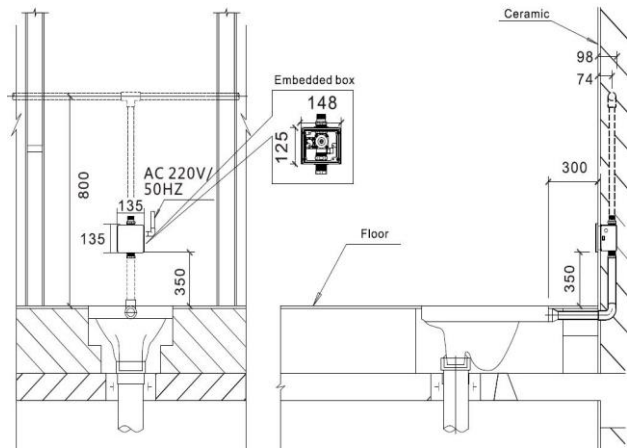

Product Feature

- 1) Automatic on/off: Infrared sensor toilet flusher automatically turns on and off (Convenience & Hygiene).
- 2) Adjustable sensor range by a remote controller.
- 3) Flush program: Normal Mode flush time 4s.
- 4) Low power indication: This may indicate it is time to replace existing batteries with new ones or there is not enough power going to unit.
- 5) Water saving: Water efficient toilet flusher reduces overall water usage without sacrificing water pressure.
- 6) Energy saving: Battery shall last approximately 3000 times/month for one year.