

FUZHOU RAJEYN ELECTRONIC SCI-TEC., LTD.

ADD: No 1 Shiziting Road, Cangshan district, Fuzhou city, Fujian Province P.C.: 350008
 Email: info@rajeyn.com Tel: +86-591-83519869

General Information	
Model	RJY-20-S105AD
Type	Concealed Urinal Sensor Flusher
Material	304 Stainless Steel Sensor Panel
Valve	Pulse solenoid valve
Net Weight	1.6kg
Gross Weight	1.9kg
Warranty	One Year
Technical Parameters	
Working Voltage	DC6V & AC220V
Average static power	<40uA
Instant dynamic power	<600mA
Working water pressure	0.05-0.7MPa
Default Sensor distance	70±7cm to Standard White Board (About 55cm to Human Body)
Adjustable Sensor Range	50-80cm to Standard White Board
Response Time	2S
Flush duration	2s pre-flush; 6s after-flush
Embedded Box/Reserved Size	158*124*96mm
Environment temperature	1~40°C
Medium temperature	0~65°C
Inlet/Outlet diameter	G1/2"
Package Information	
Inner package	375*165*112
Outer package	525*395*360
Quantity per carton	9

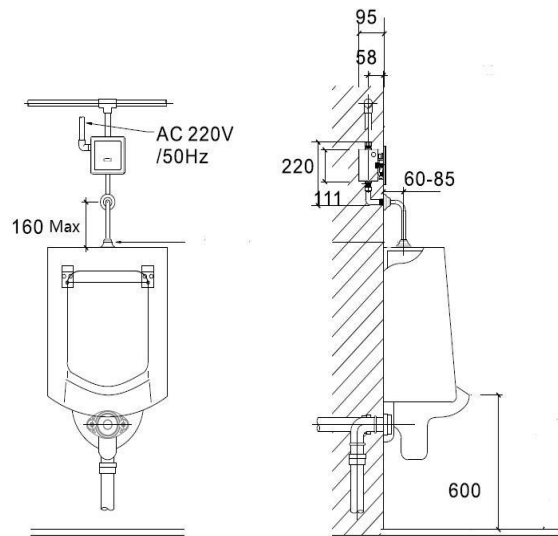

Product Feature
1) Automatic on/off: Infrared sensor urinal flusher automatically turns on and off (Convenience & Hygiene).
2) Adjustable sensor range by a remote controller (optional).
3) Flush program: 2s for pre-flush & 6s for after-flush.
4) Automatically flush if no usage in 24 hours.
5) Low power indication: This may indicate it is time to replace existing batteries with new ones or there is not enough power going to unit.
6) Water saving: Water efficient urinal flusher reduces overall water usage without sacrificing water pressure.
7) Energy saving: Battery shall last approximately 3000 times/month for one year.